

Power Source

Starting and Ignition

Charging

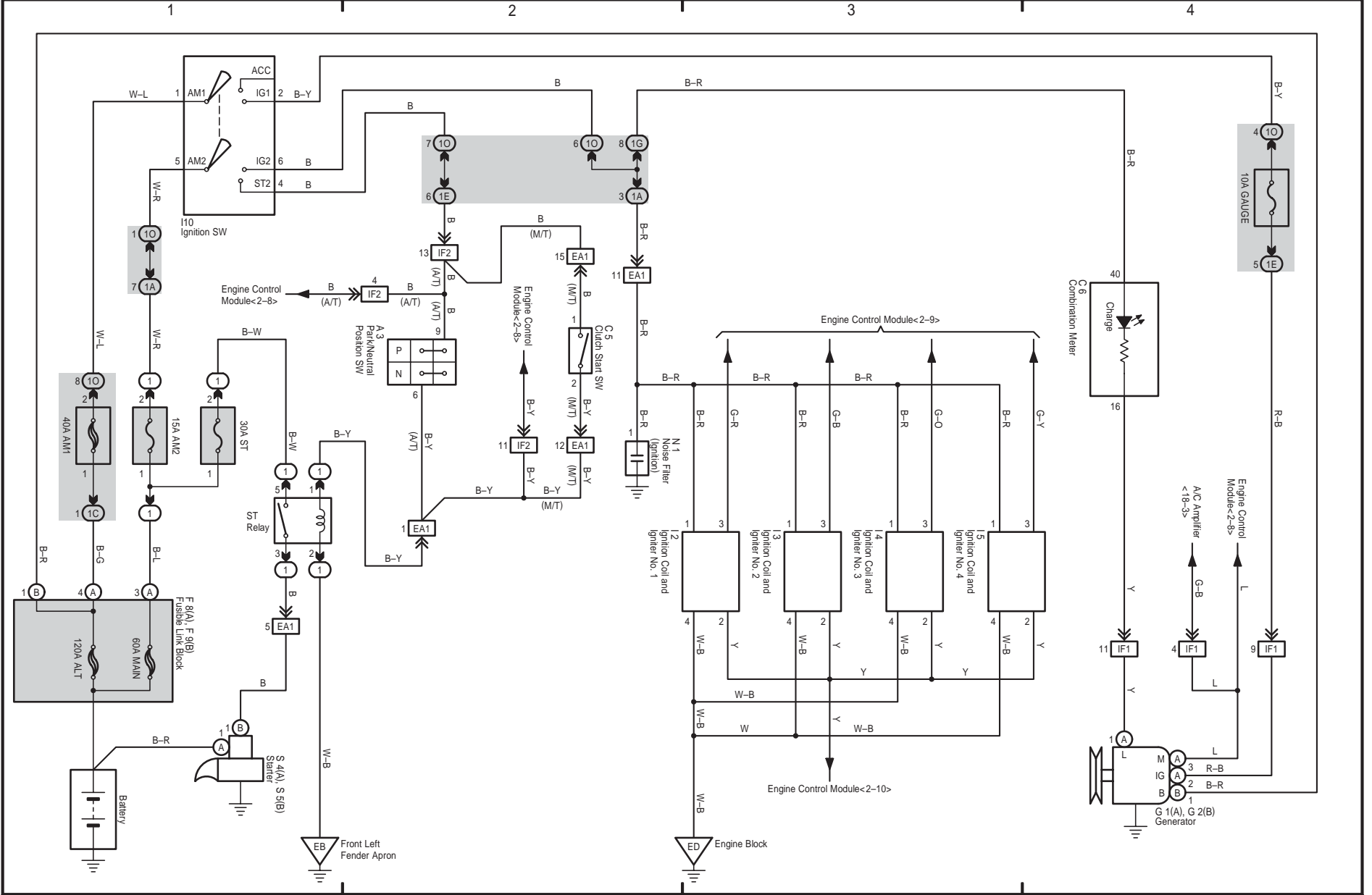

SCION xB (EM0090U)



M OVERALL ELECTRICAL WIRING DIAGRAM

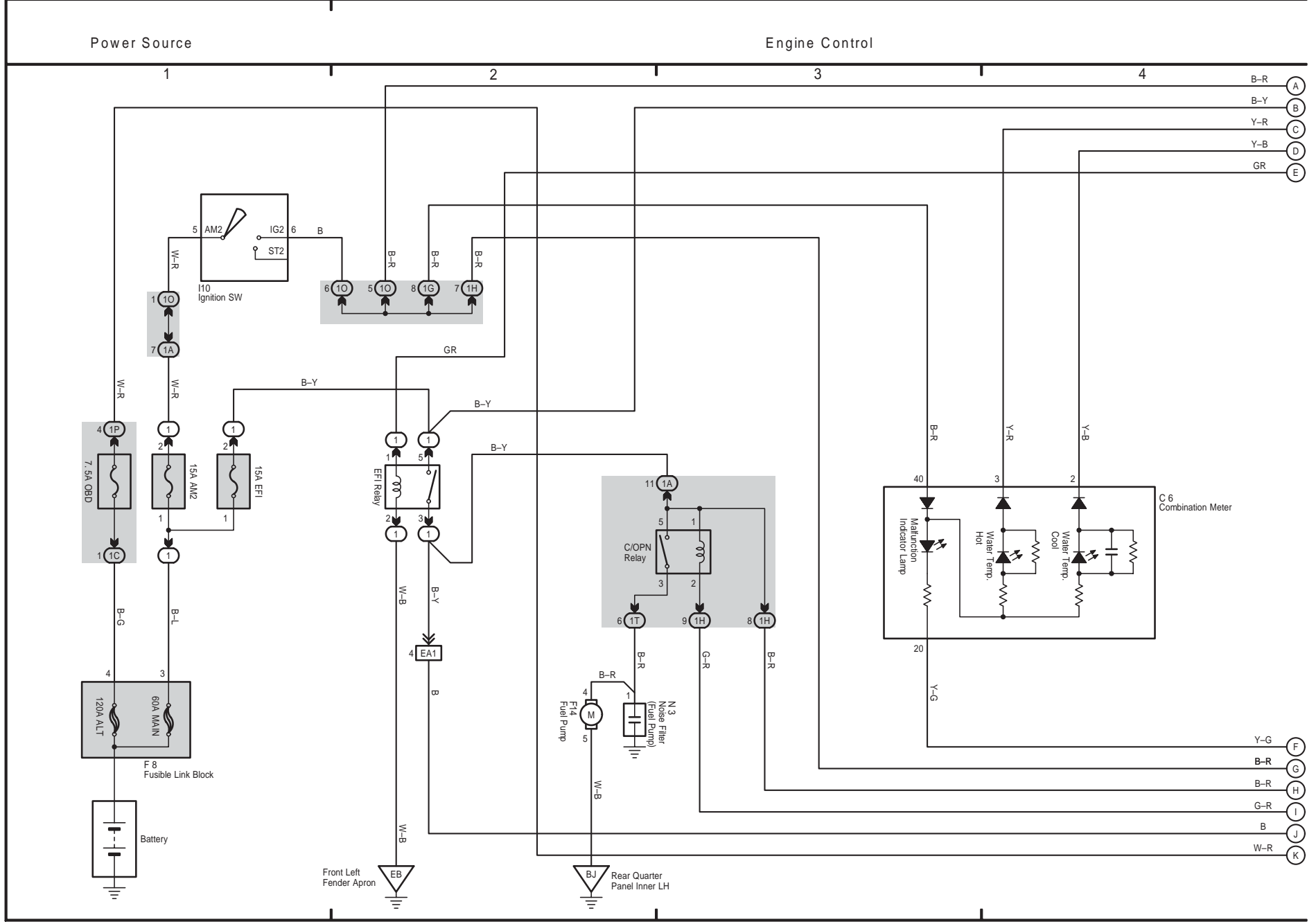

Engine Control

\* 1 : Shielded

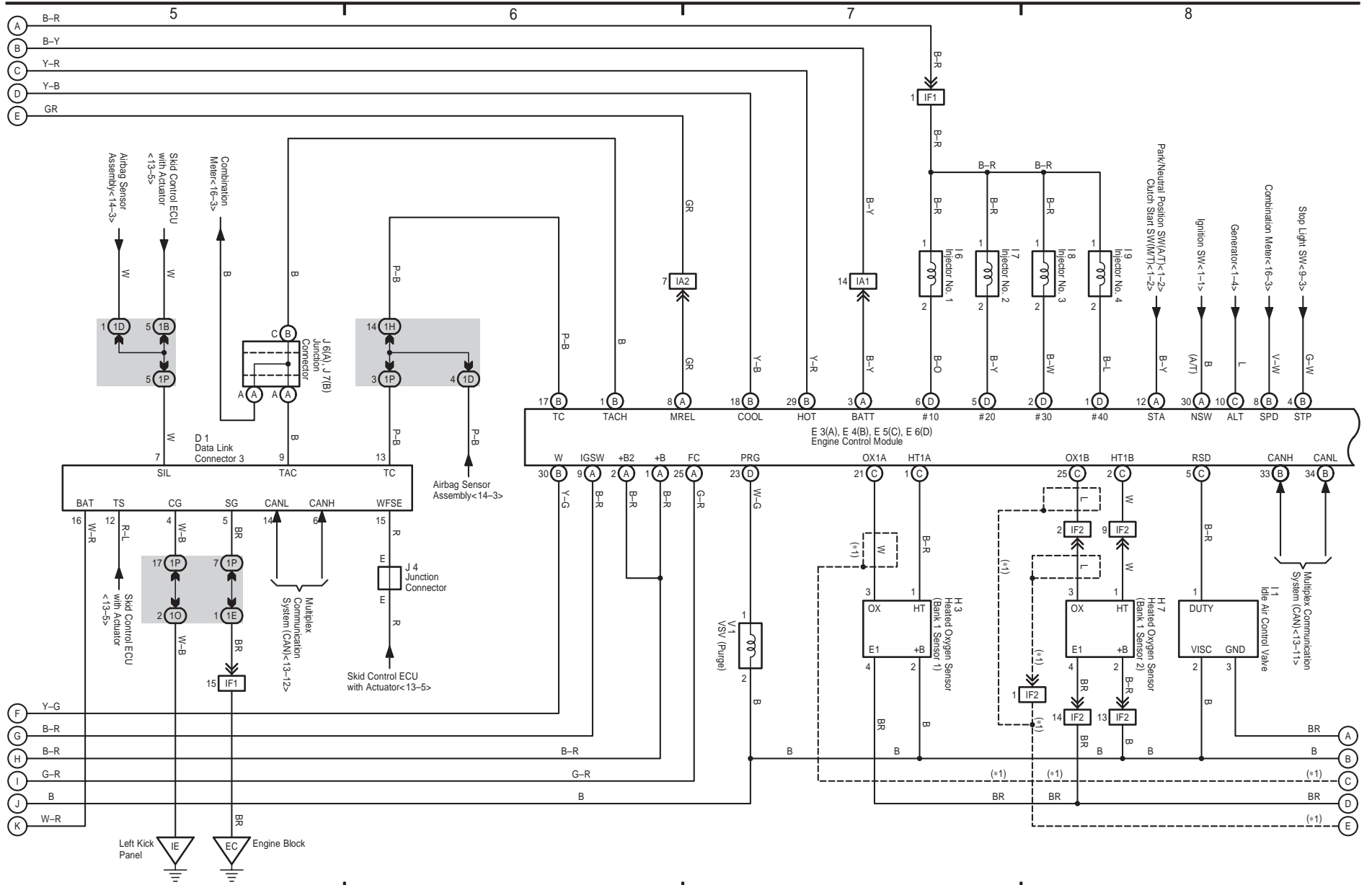

SCION xB (EM0090U)



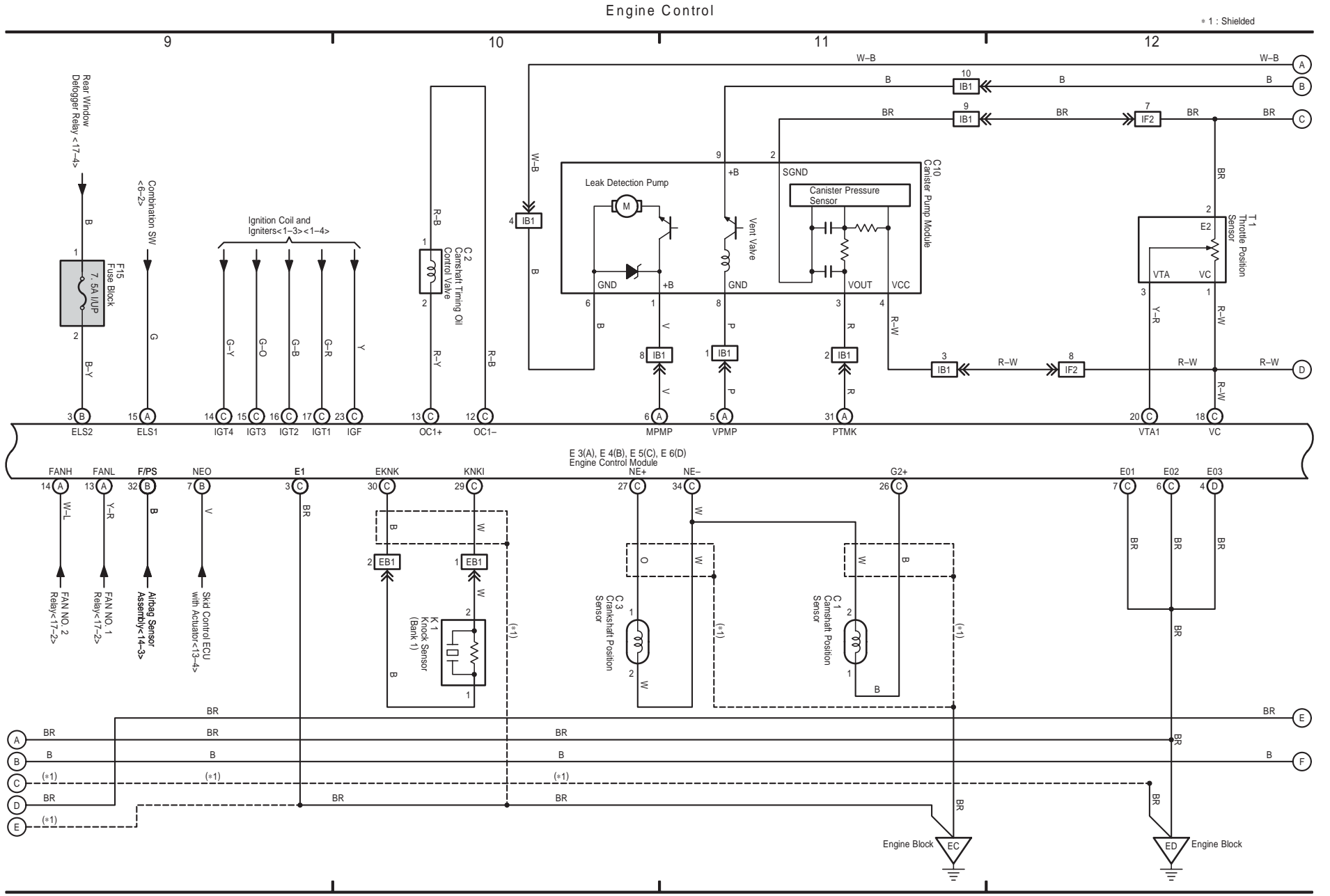

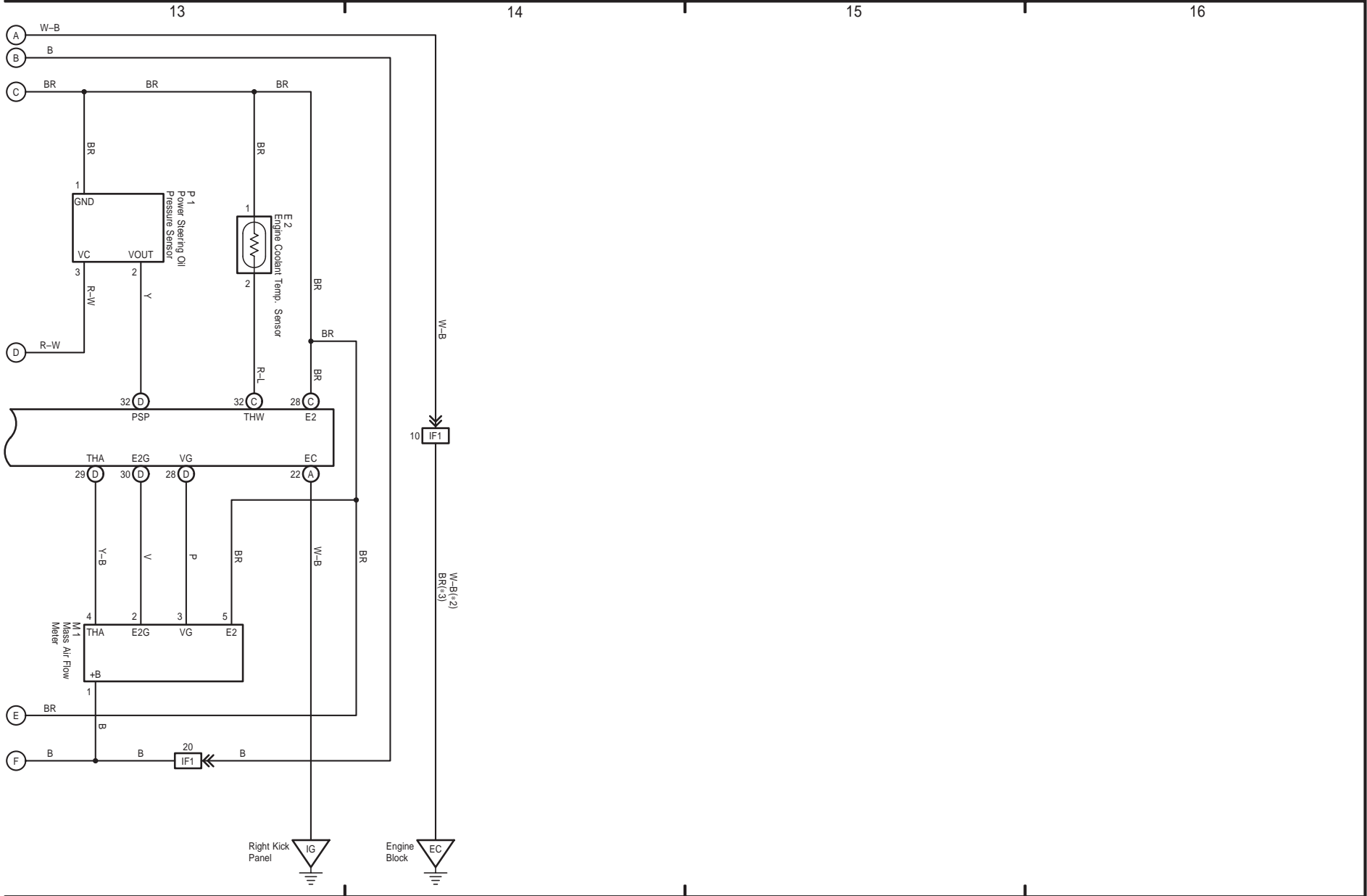

SCION xB (EM0090U)



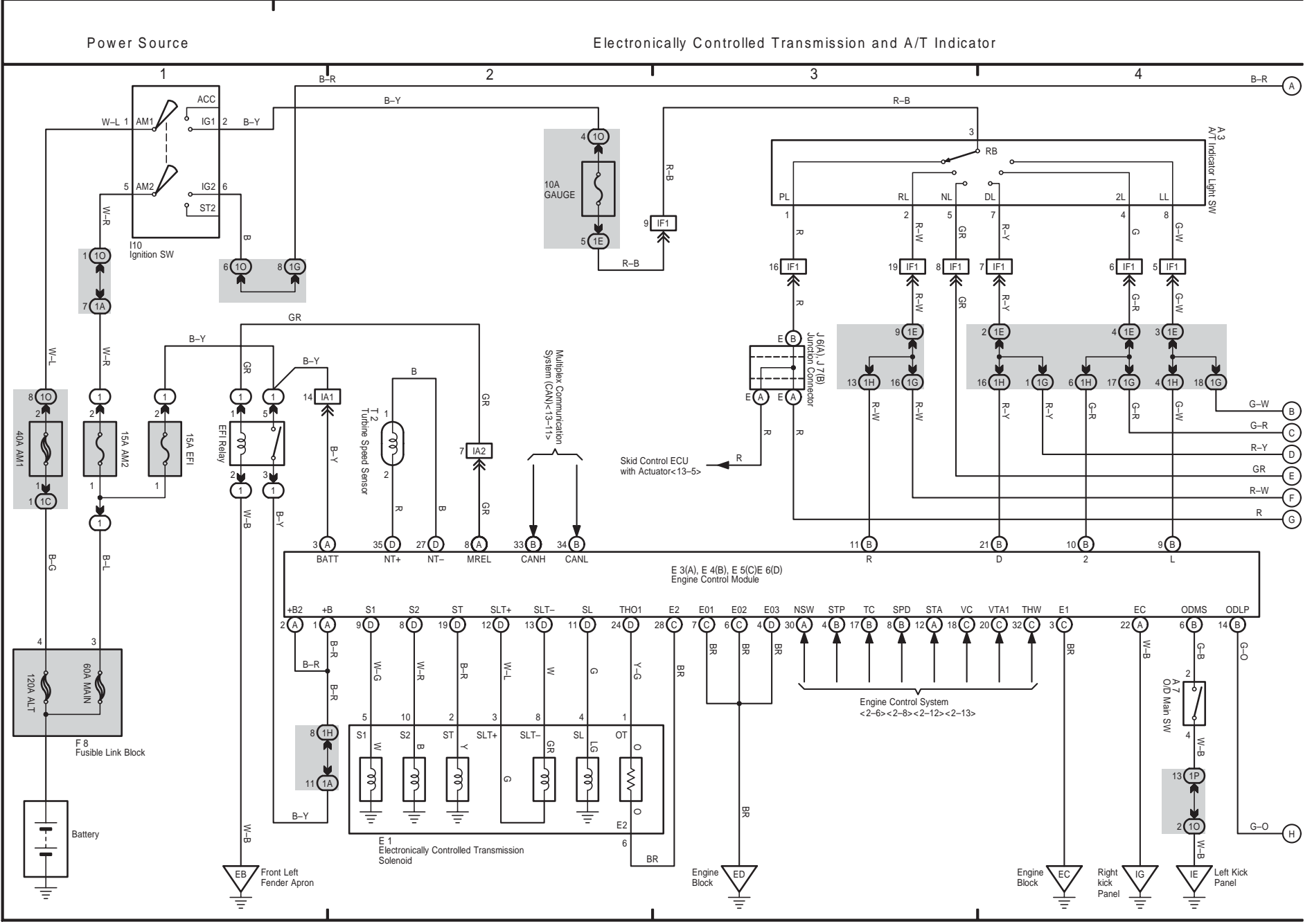

Electronically Controlled Transmission and A/T Indicator

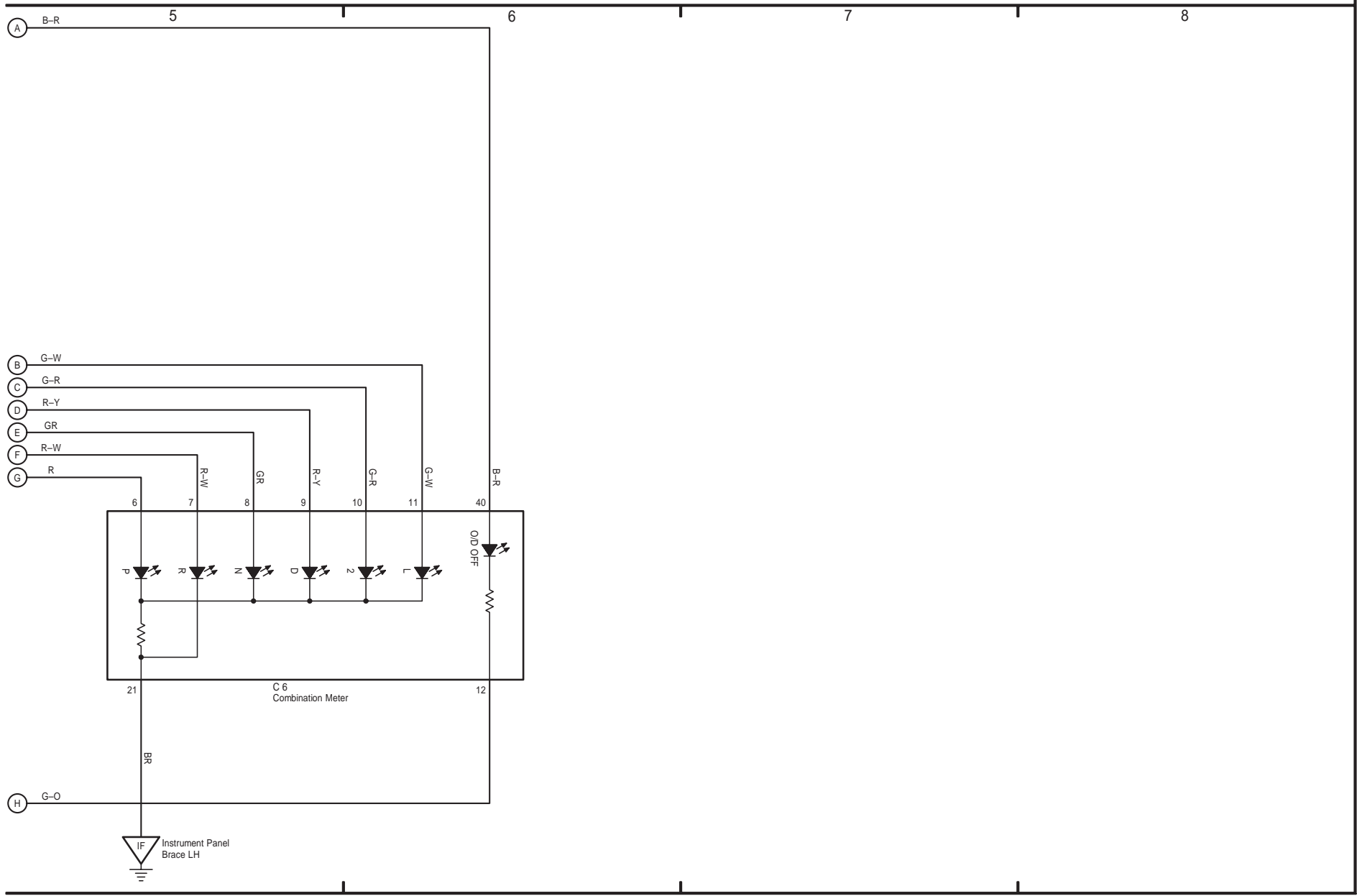

SCION xB (EM0090U)

4 xB

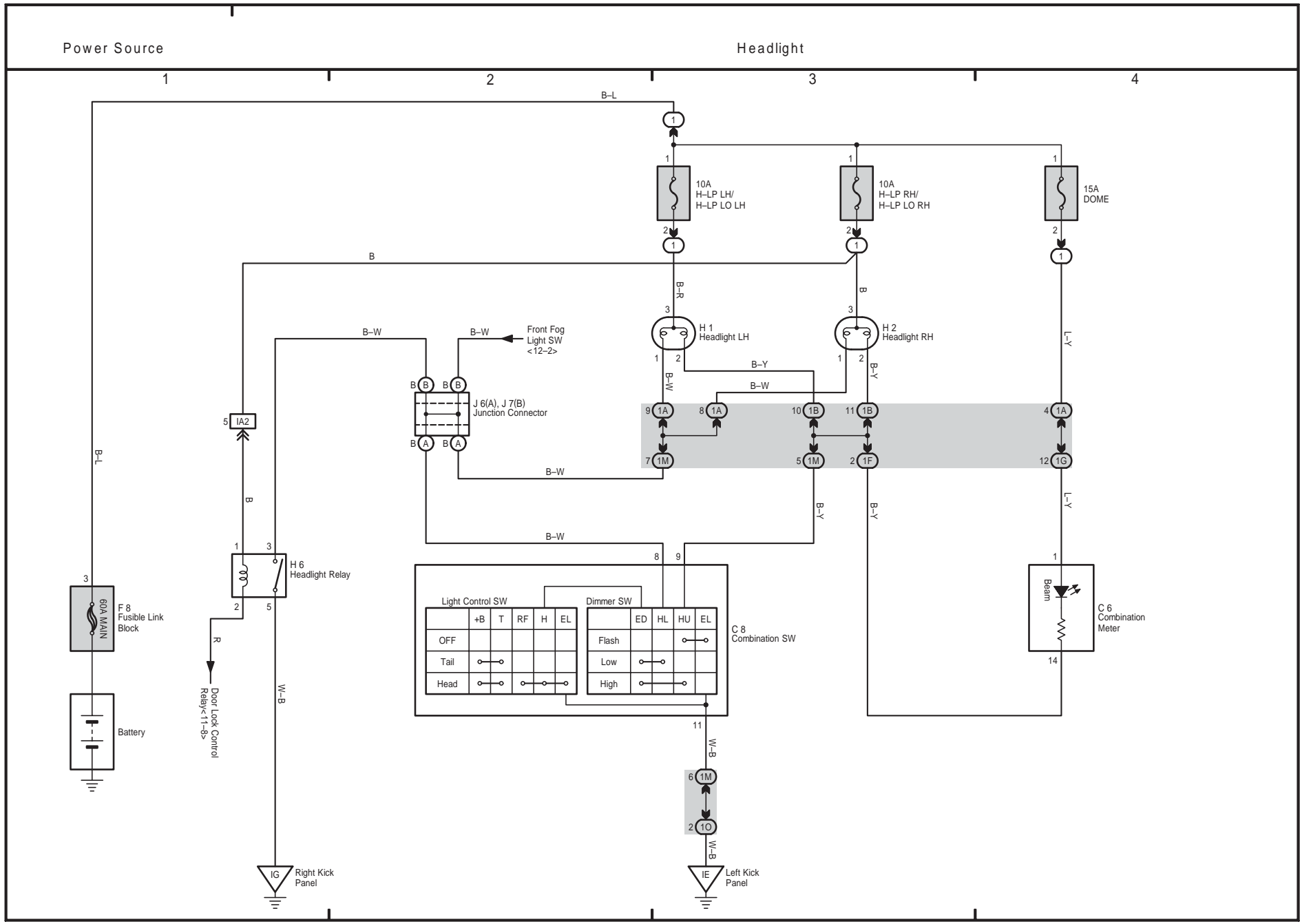



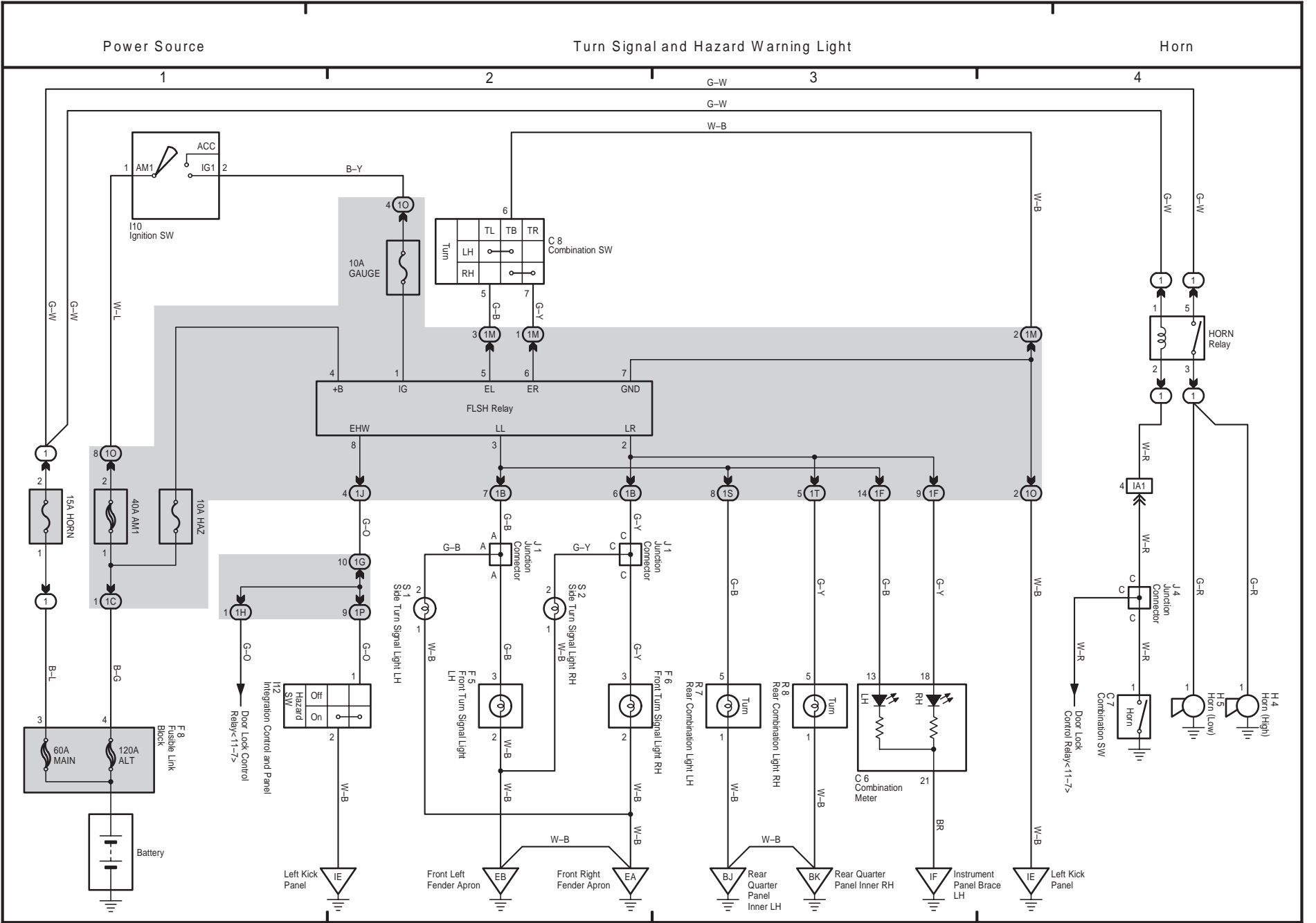

# M OVERALL ELECTRICAL WIRING DIAGRAM

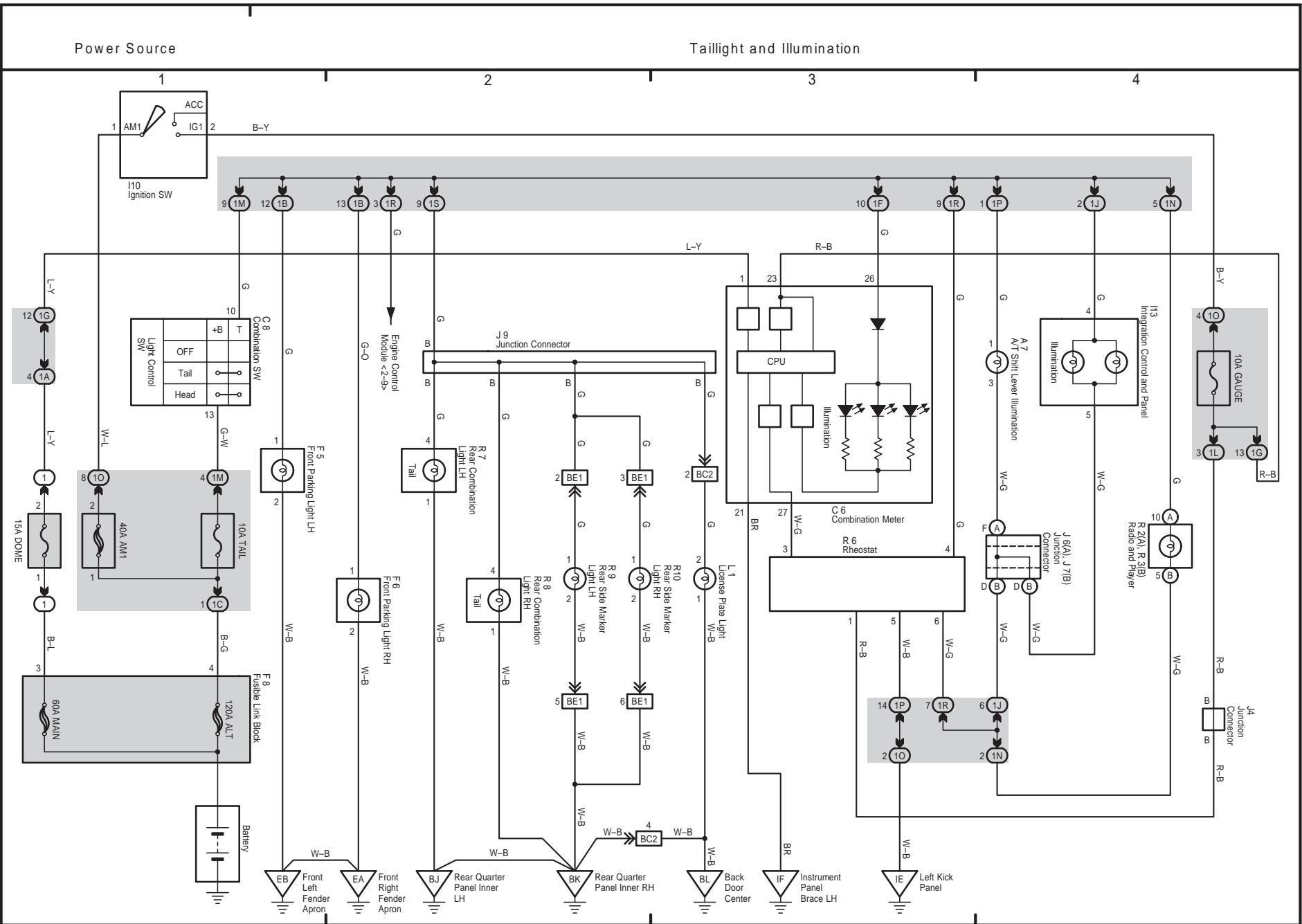

6 xB

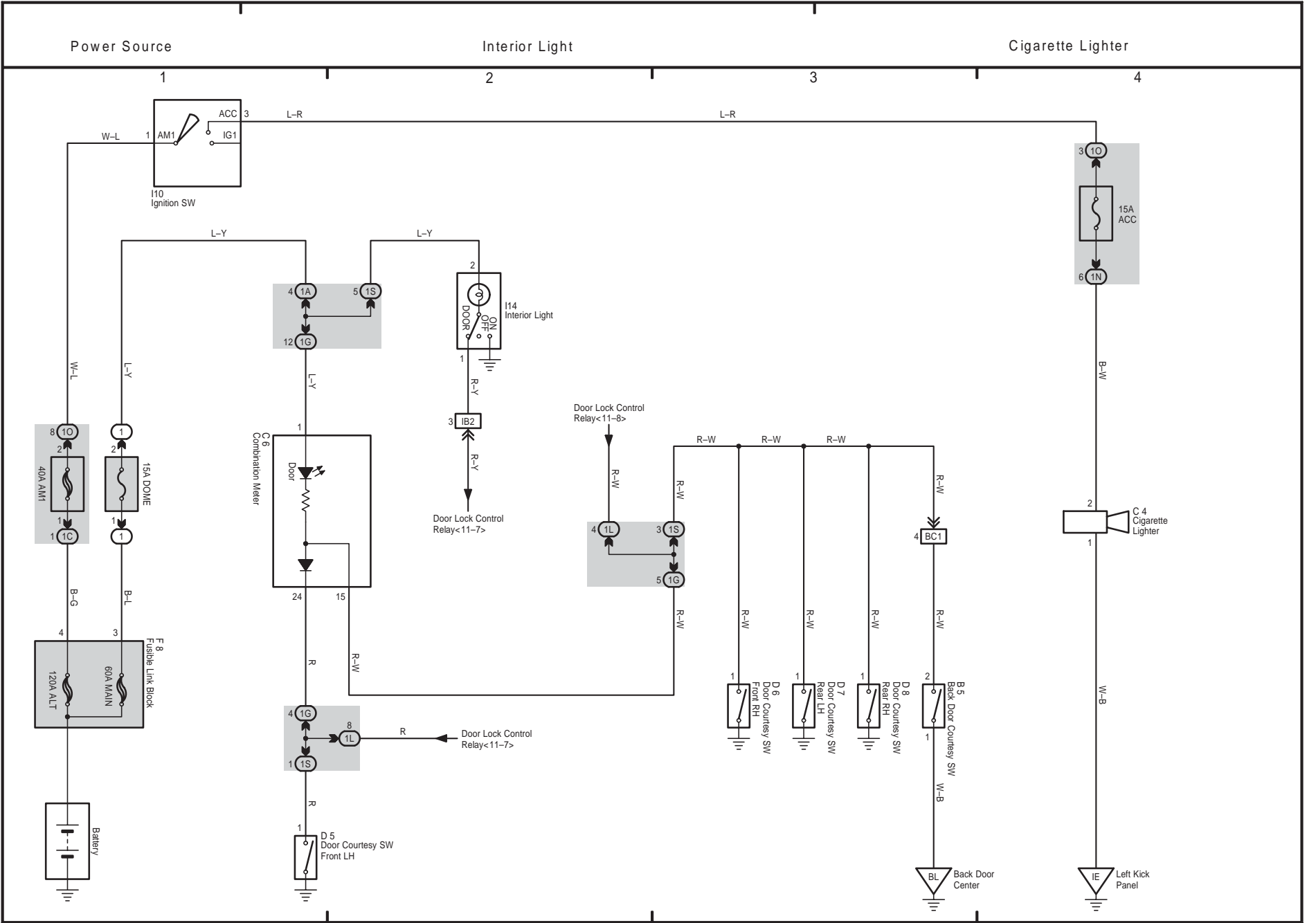

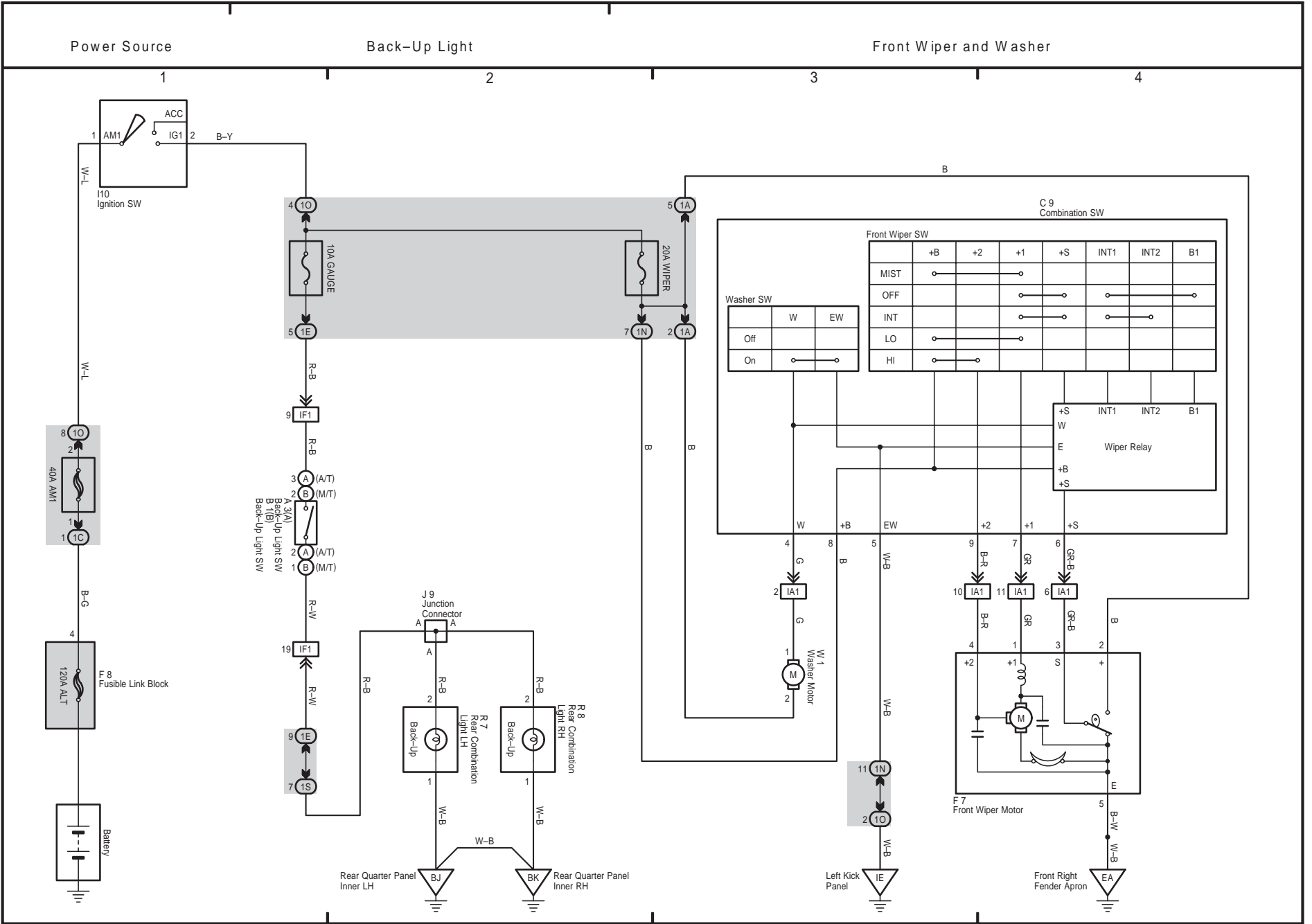

Power Source

Light Reminder

Key Reminder and Seat Belt Warning

Shift Lock

Stop Light

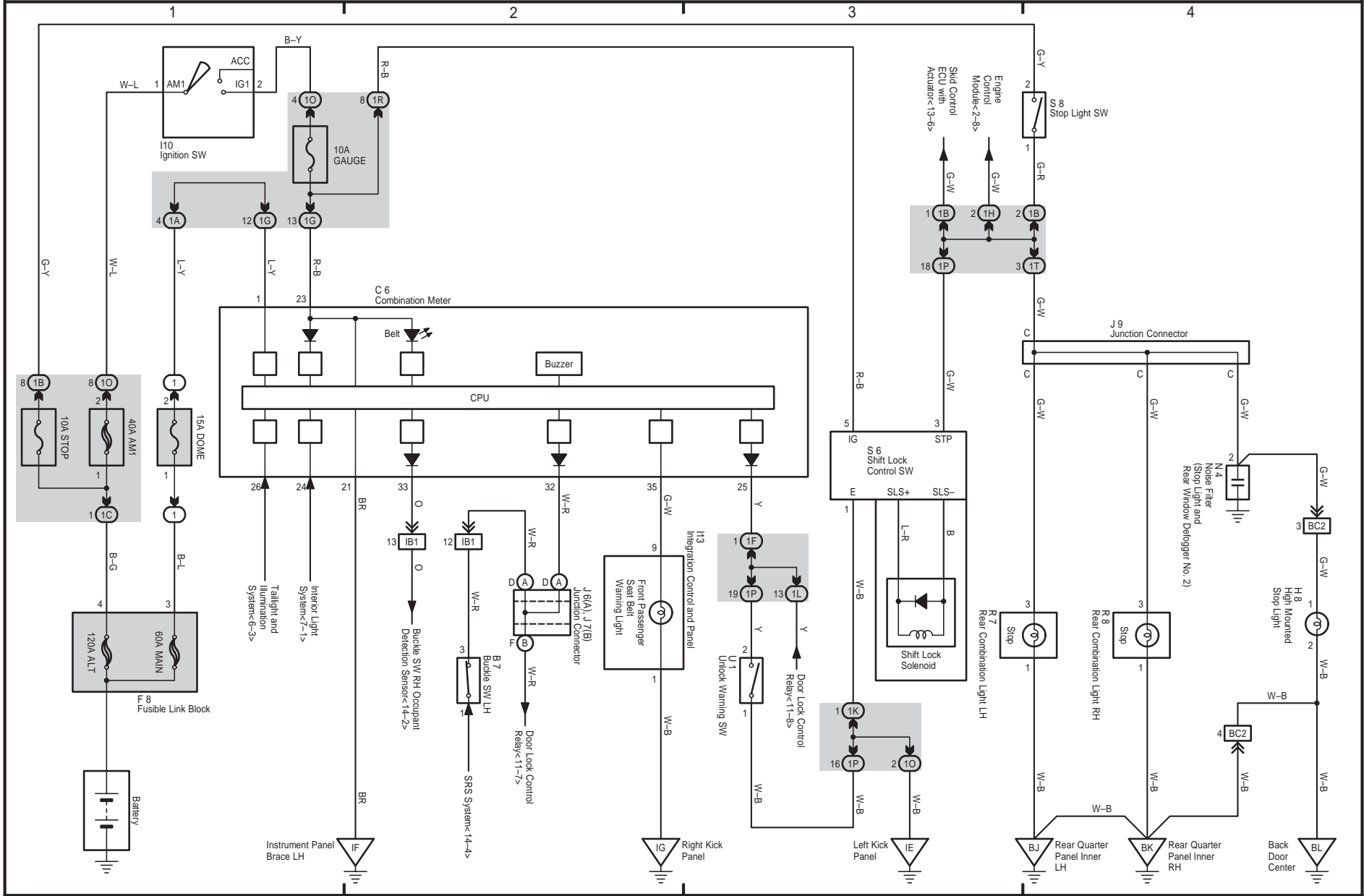

SCION xB (EM0090U)



M OVERALL ELECTRICAL WIRING DIAGRAM

10 xB

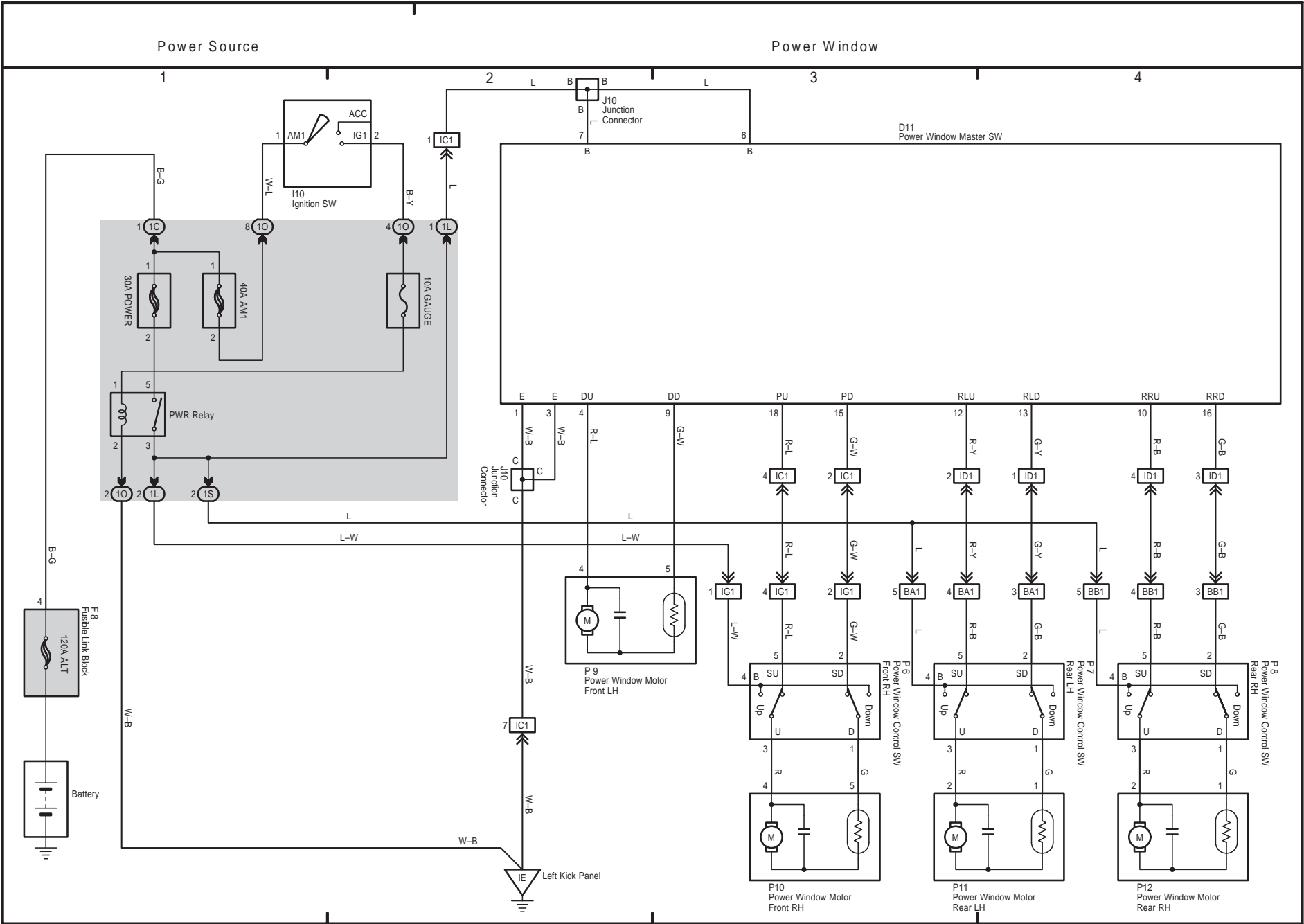



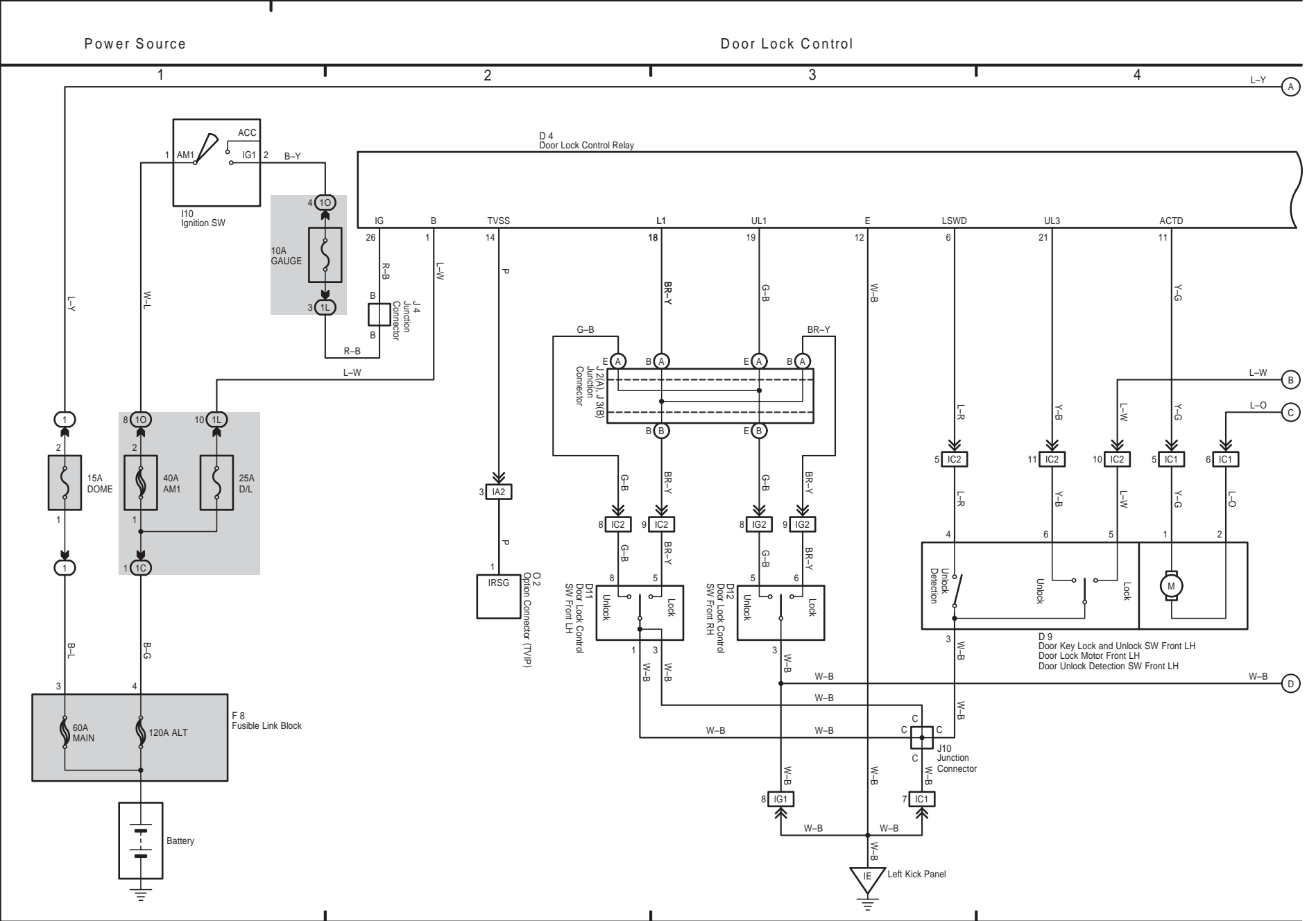

M OVERALL ELECTRICAL WIRING DIAGRAM



Door Lock Control

Wireless Door Lock Control

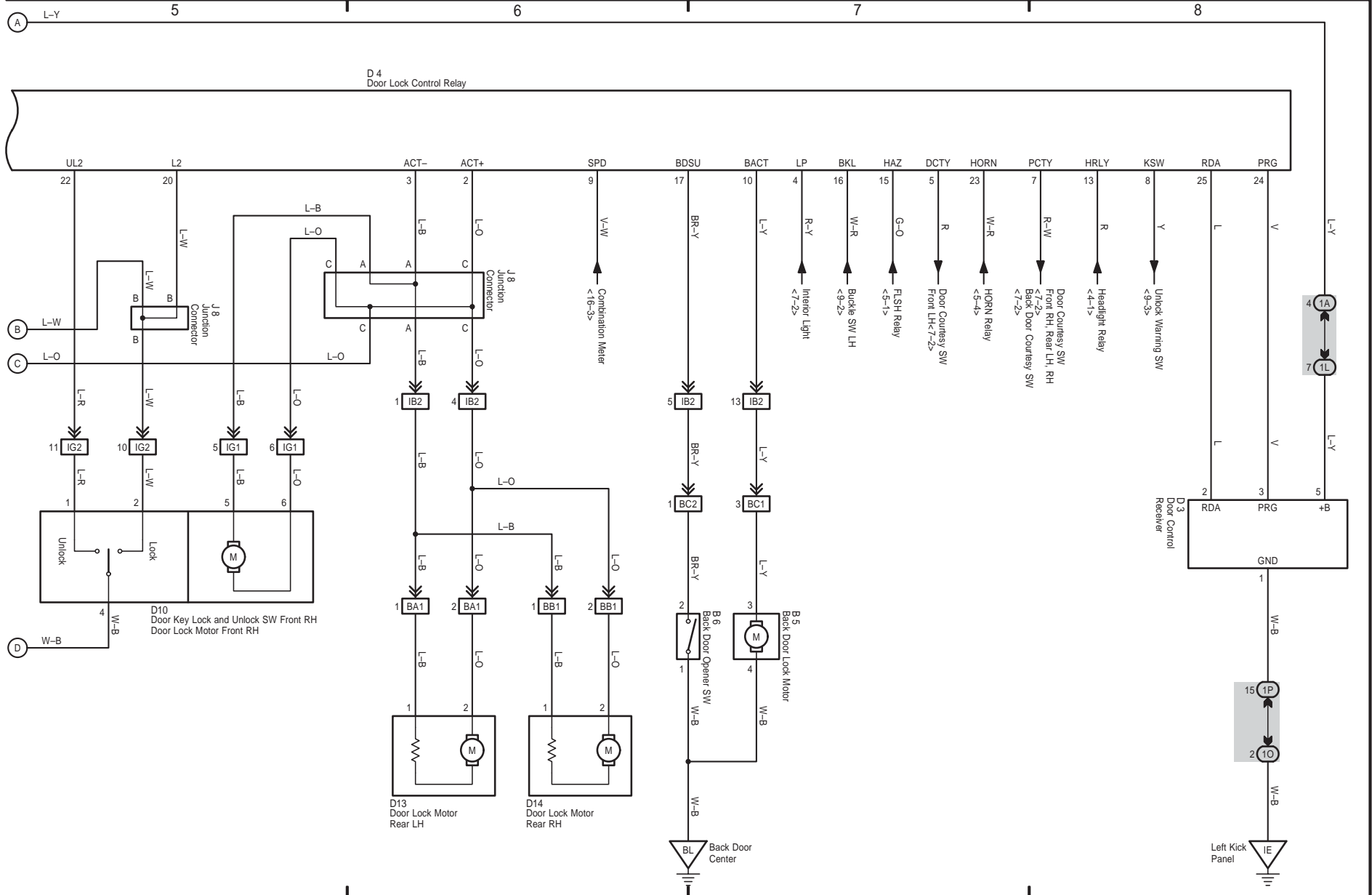

SCION xB (EM0090U)



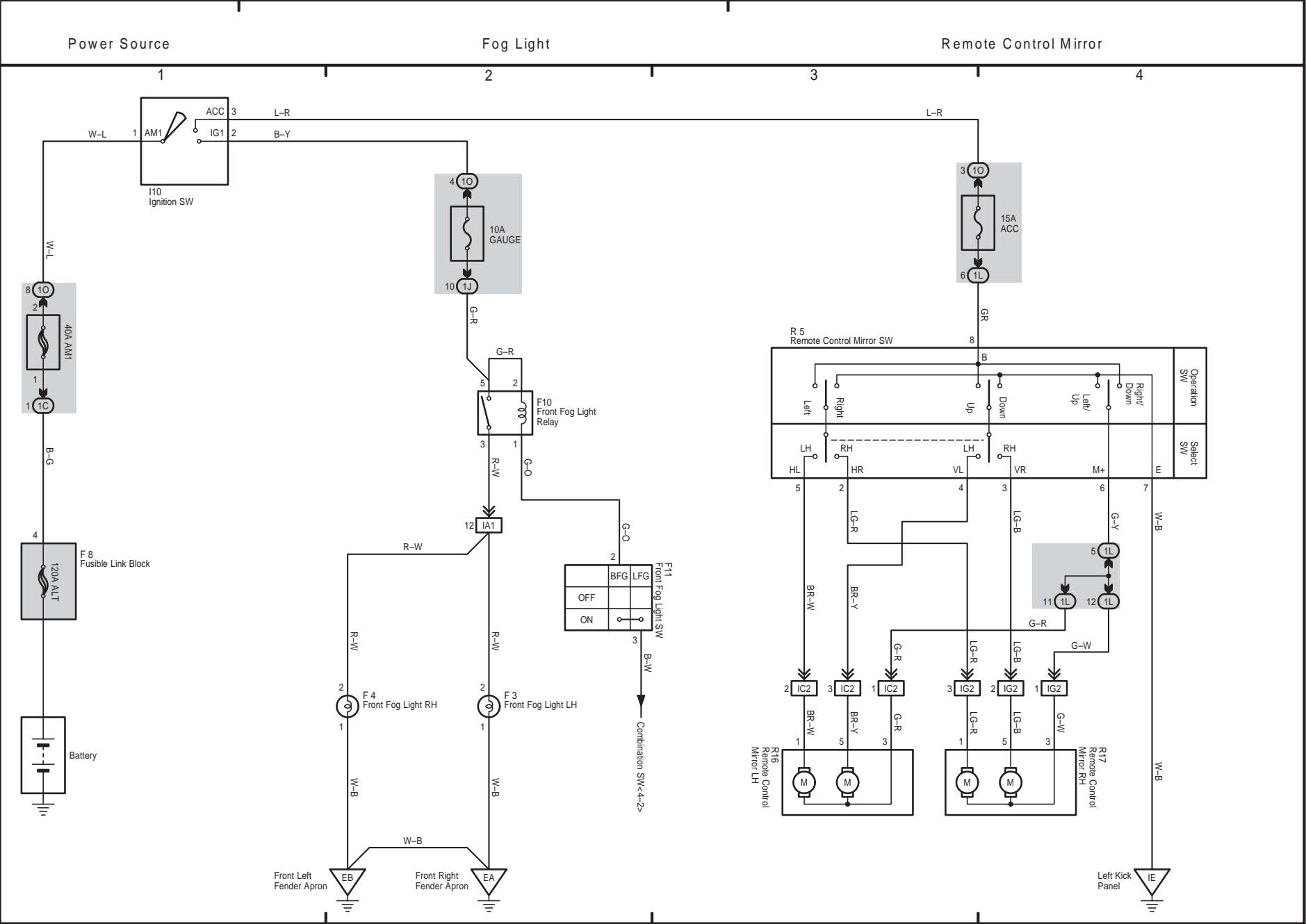

M OVERALL ELECTRICAL WIRING DIAGRAM



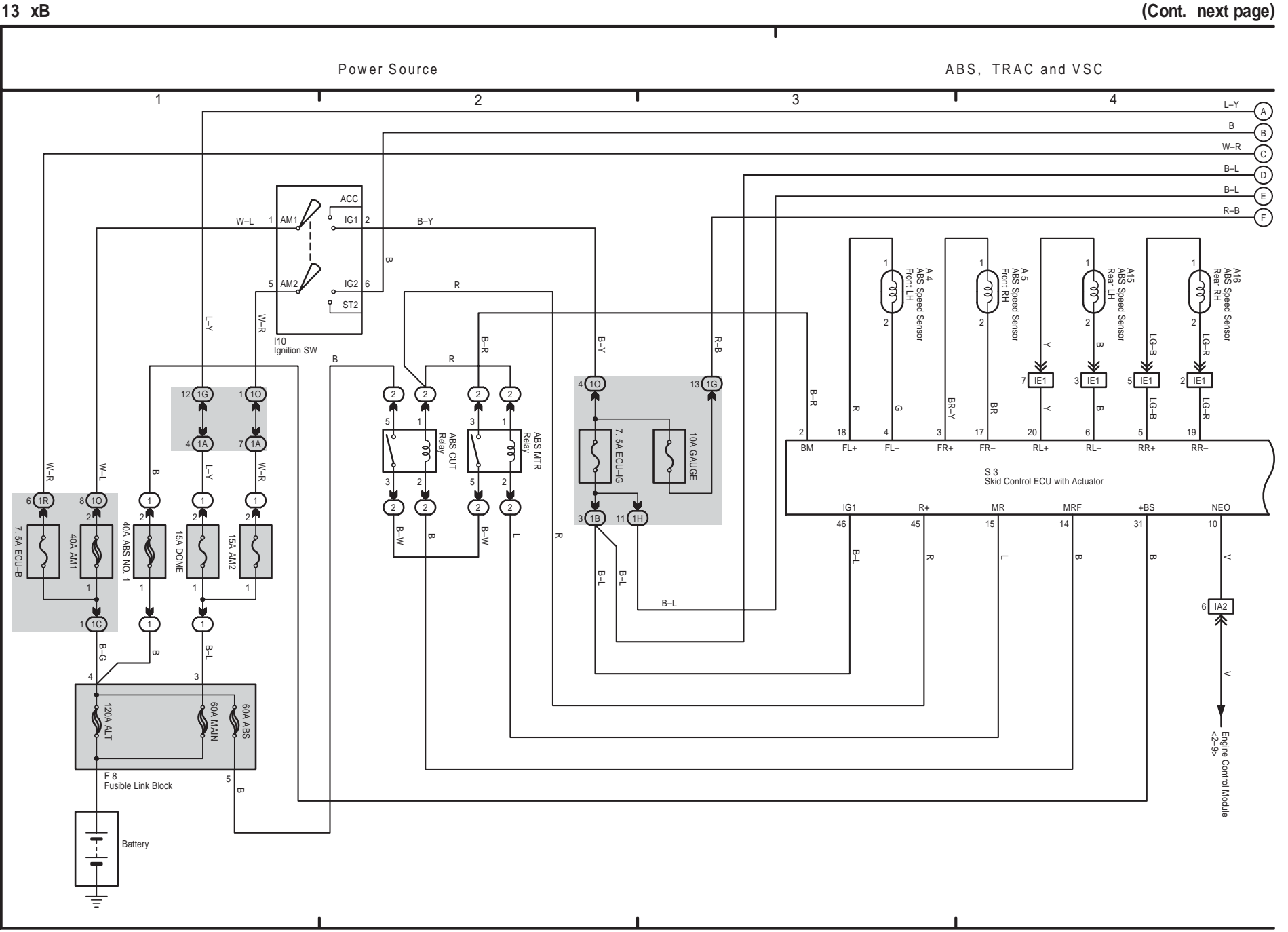

ABS, TRAC and VSC

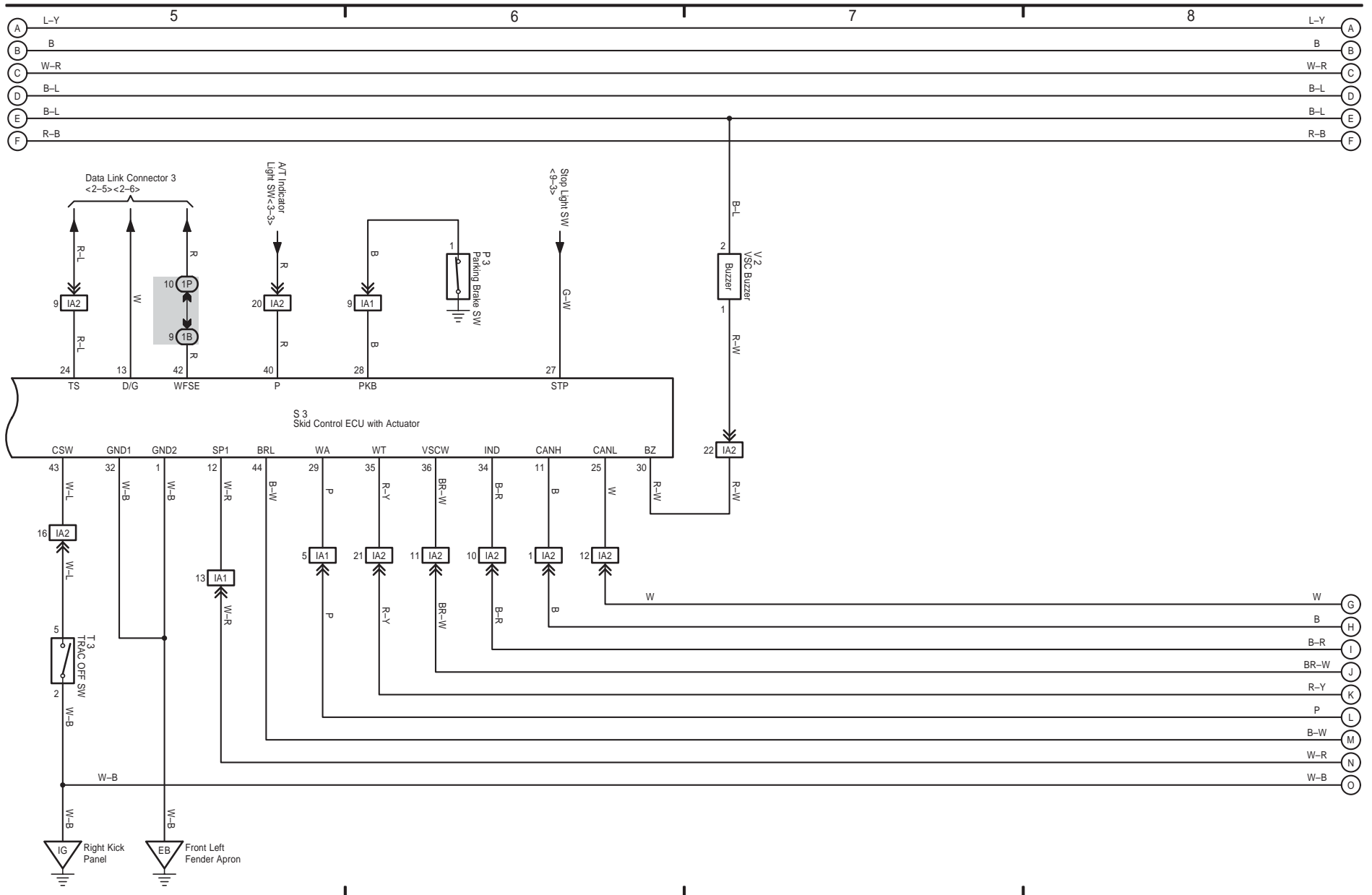

SCION xB (EM0090U)



13 xB (Cont' d)

ABS, TRAC and VSC

Multiplex Communication System (CAN)

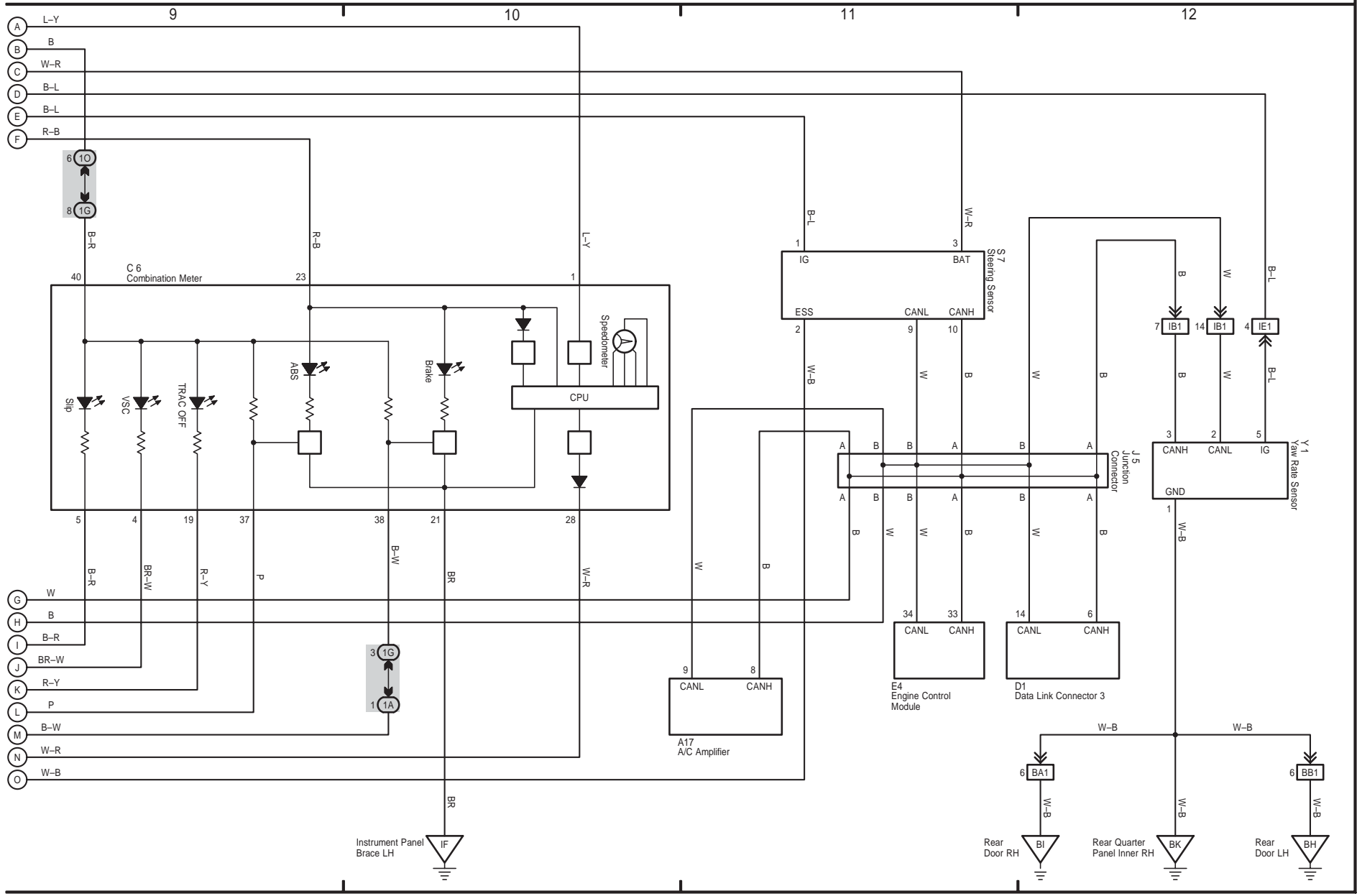

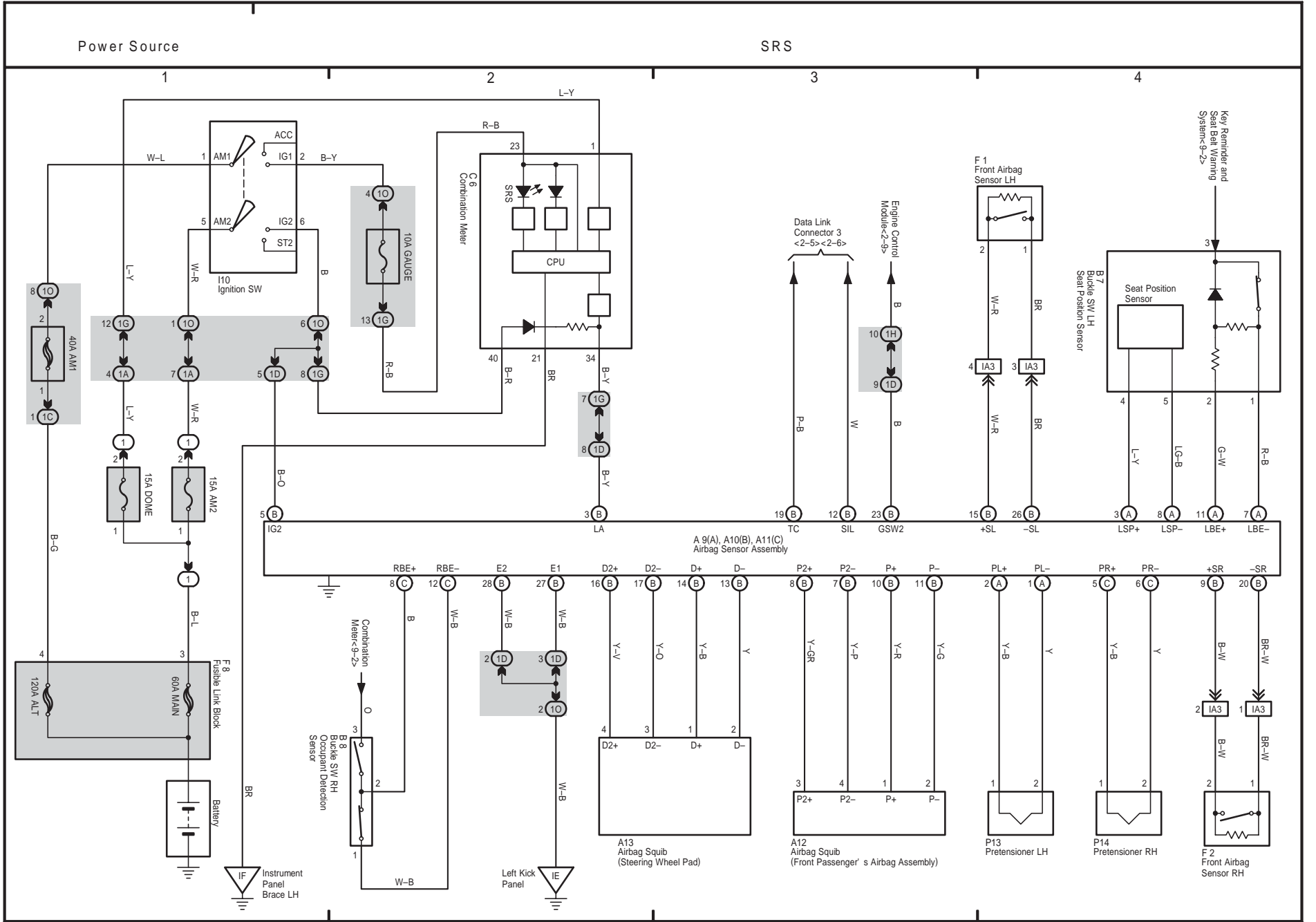

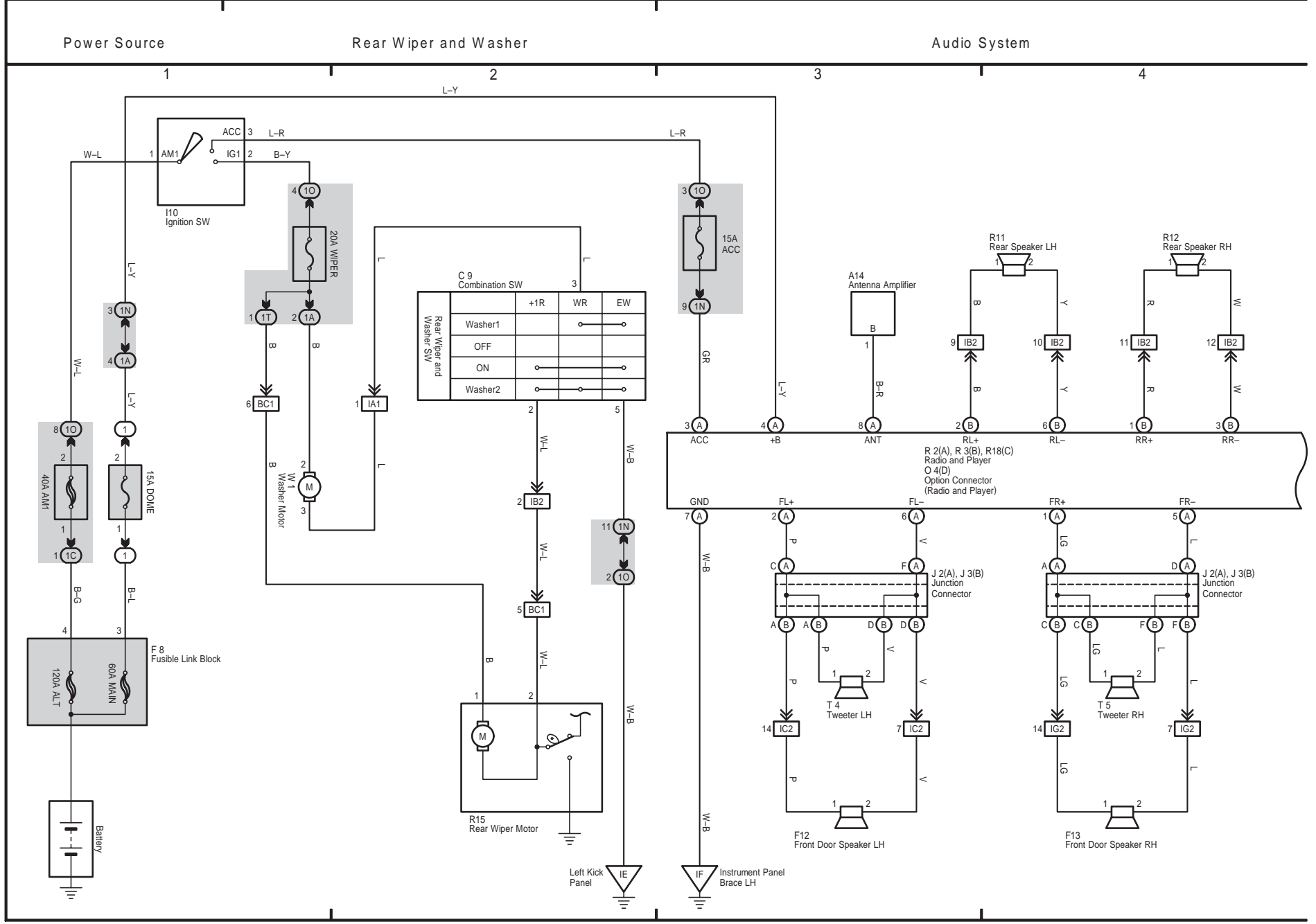



Audio System

5 6 7 8

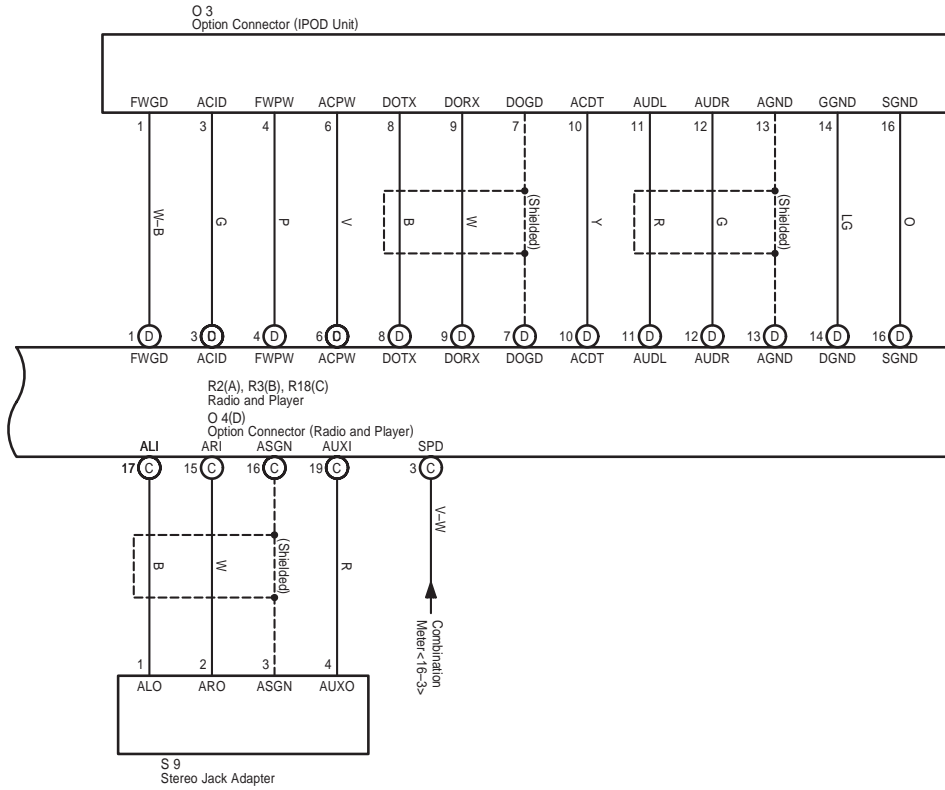

SCION xB (EM0090U)

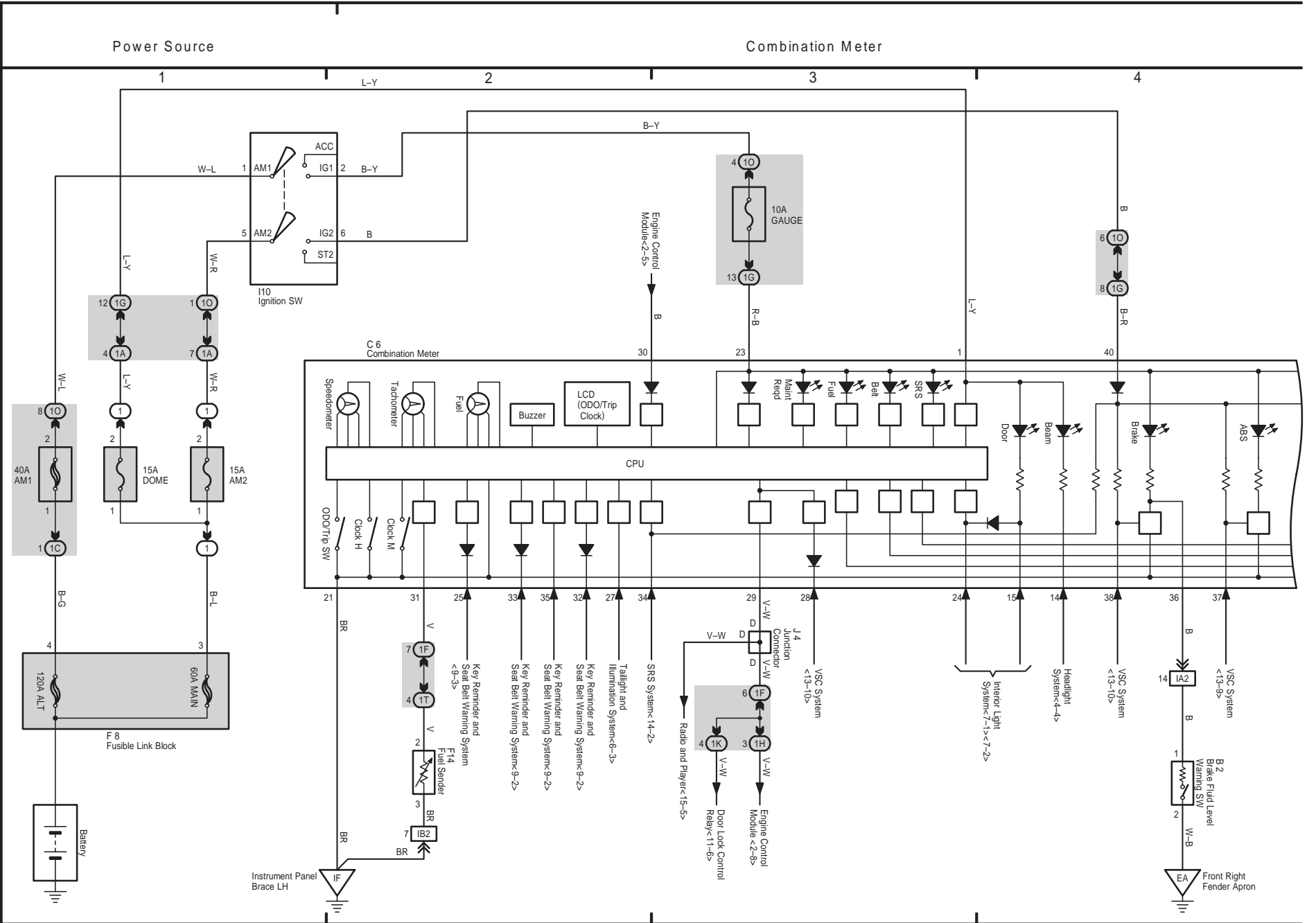

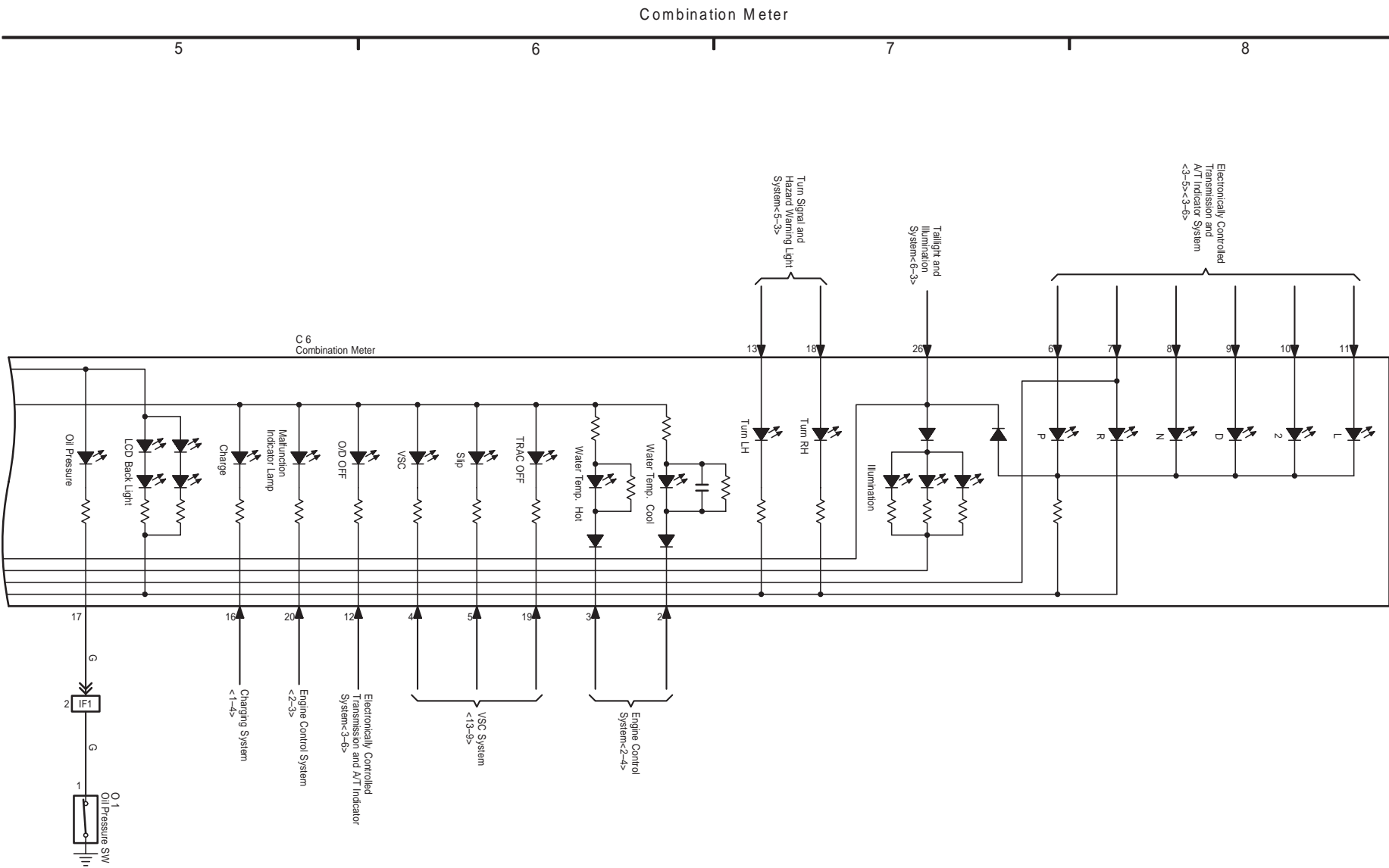

Combination Meter

SCION xB (EM0090U)

# OVERALL ELECTRICAL WIRING DIAGRAM

17 xB

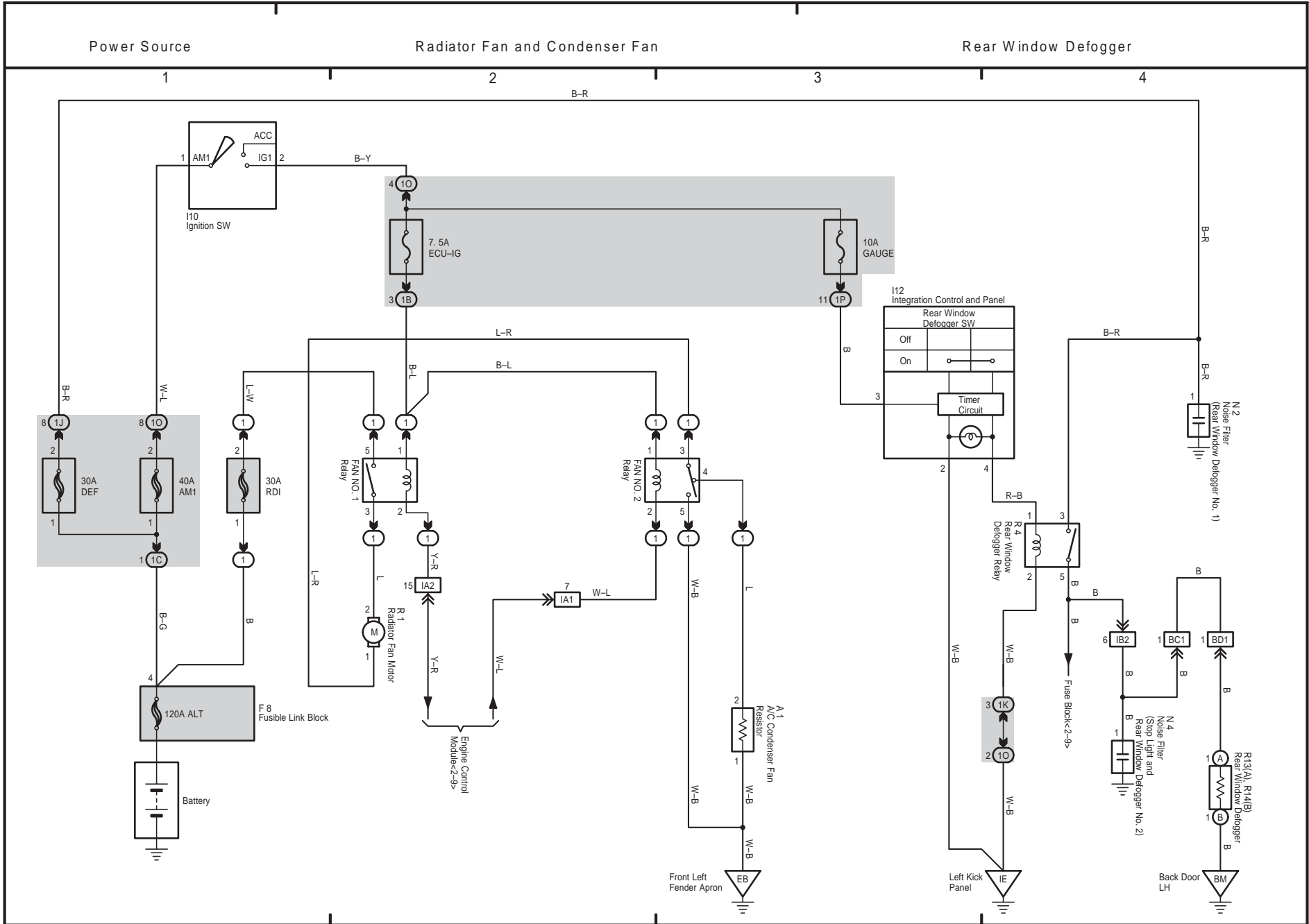

206

SCION xB (EM0090U)



OVERALL ELECTRICAL WIRING DIAGRAM

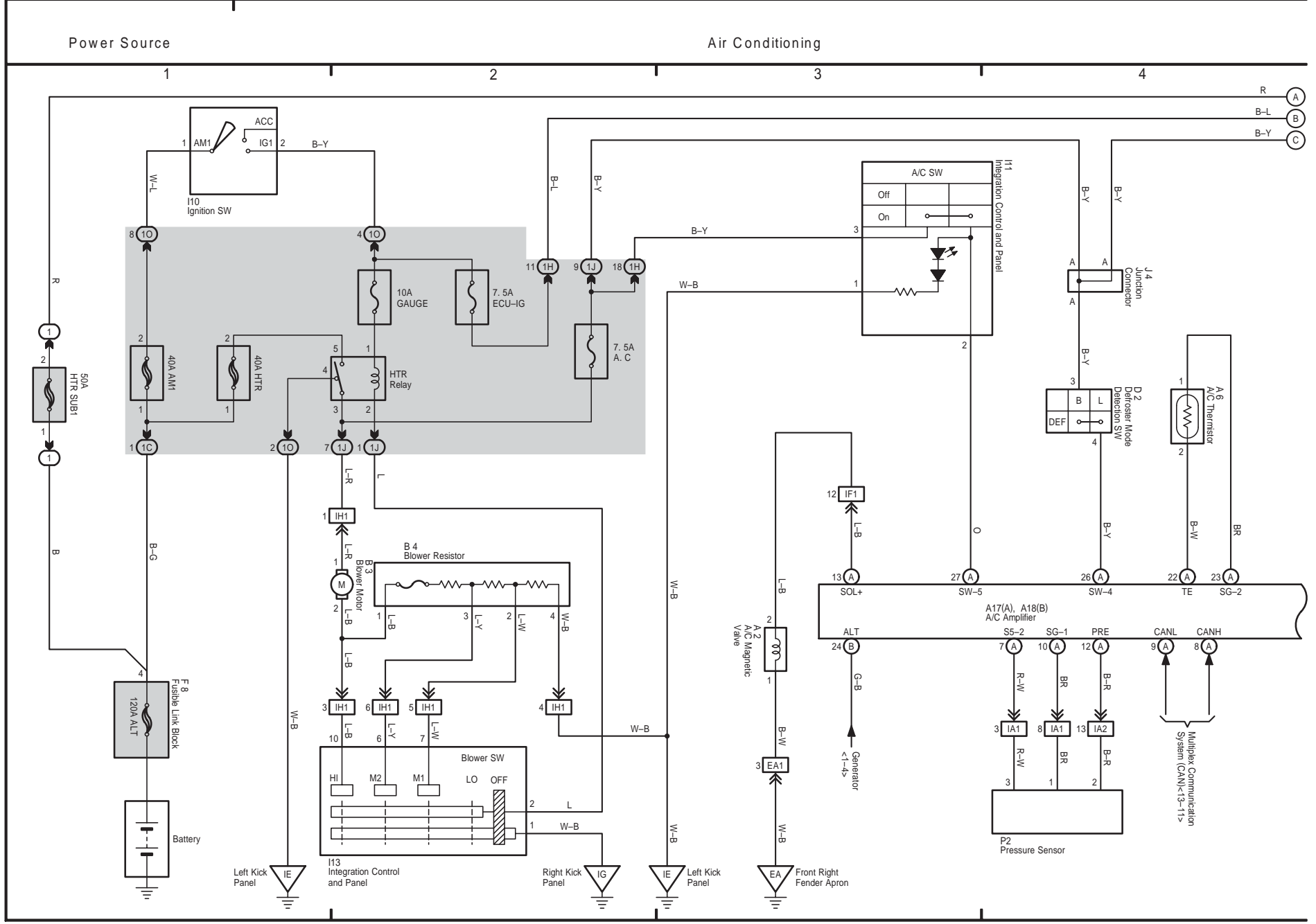

Two Way Flow Heater

PTC Heater

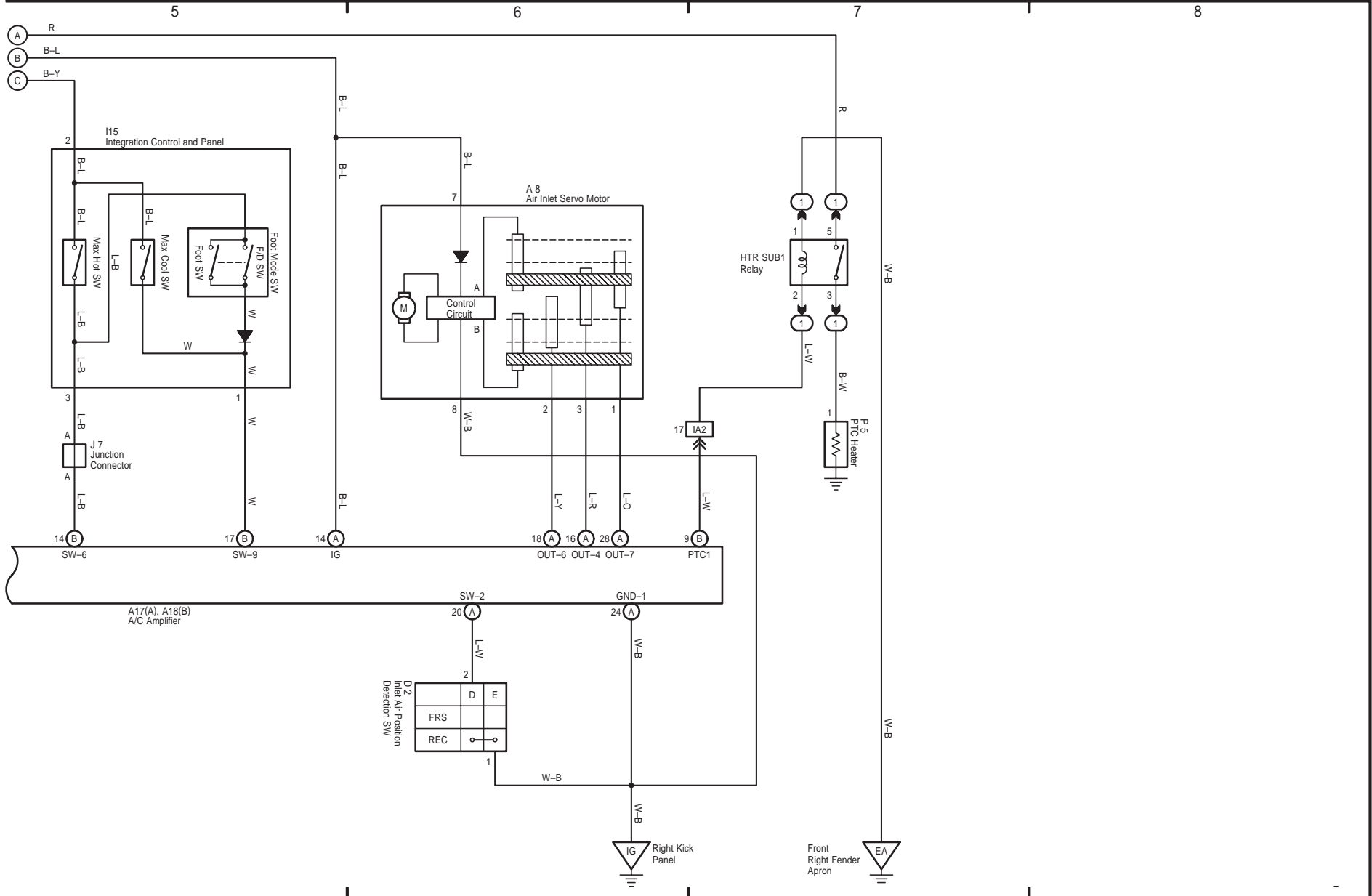

SCION XB (EM0090U)